

4 Channels 0/1-10V DMX512 Decoder

- Comply with the DMX512 standard protocols.
- Digital numeric display, set DMX decode start address by buttons.
- RDM function can realize intercommunication between DMX master and decoder. For example, DMX decoder address can be set by DMX master console.
- 1/2/4 DMX channel output selectable.
- 0-10V or 1-10V output selectable.
- Logarithmic or linear dimming curve selectable.
- Stand-alone RGB/RGBW mode and 4 channel dimmer mode selectable, which be controlled by buttons with built-in programs, instead of DMX signal.
- Available in white or black.

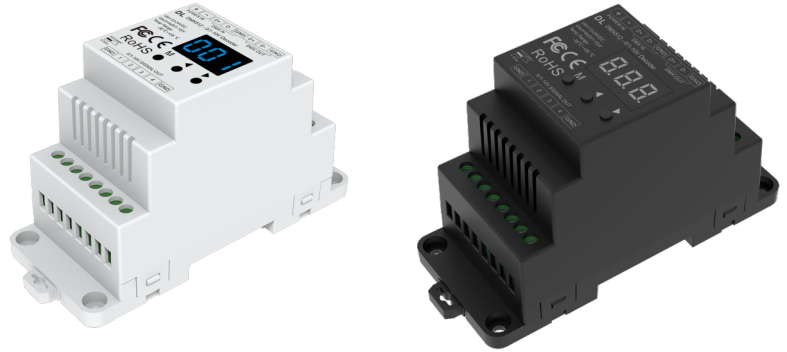

FC CE RoHS

Technical Parameters

Input and Output		Environment		Safety and EMC	
Input voltage	12-24VDC	Operation temperature	Ta: -30°C ~ +55°C	EMC standard	EN IEC 55015:2019+A11:2020
Input signal	DMX512	Case temperature (Max.)	Tc: +65°C		EN 61547:2009
Output signal	0/1-10V analog	IP rating	IP20		EN IEC 61000-3-2:2019+A1:2021 EN 61000-3-3:2013+A1:2019
Output current	4CH, 20mA/CH	Package		Safety standard	EN 61347-1:2015+A1:2021
Warranty		Size	L120 x W78 x H55mm		EN 61347-2-13:2014+A1:2017
Warranty	5 years	Gross weight	0.132kg	Certification	CE

Mechanical Structures and Installations

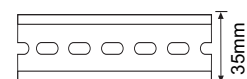
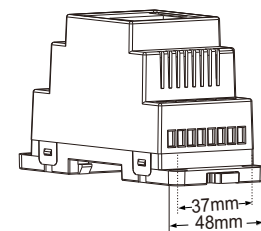
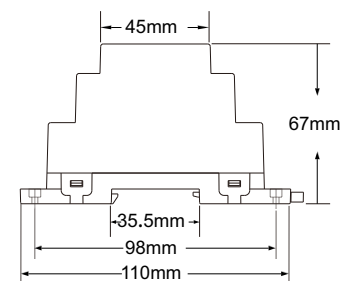
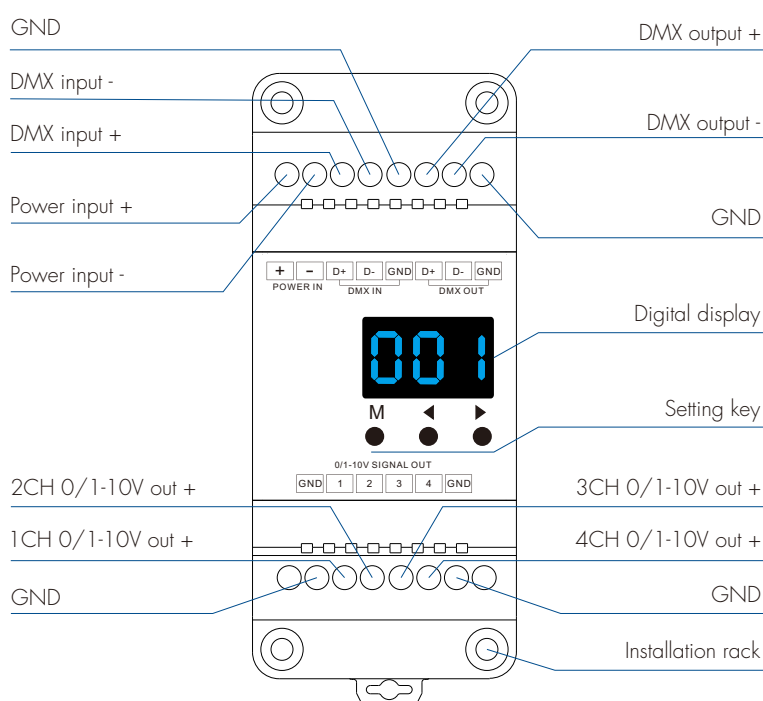

DIN Rail Mounting Size:
TS-35/7.5 or TS-35/15

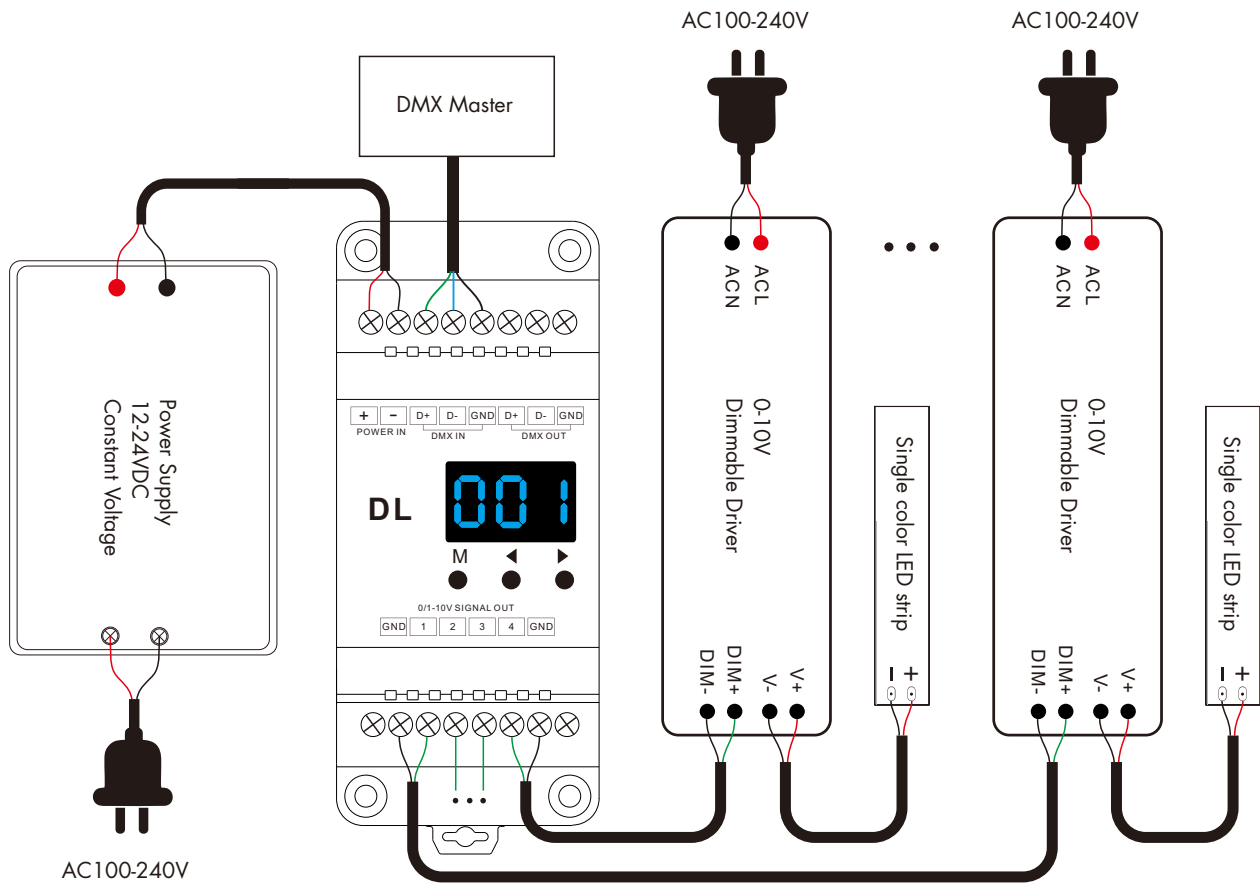

Note: We recommend the number of LED drivers connected to 0/1-10V dimmer (each channel) does not exceed 20 pieces, The maximum length of the wires from dimmer to LED driver should be no more than 30 meters.

Operation

System parameter setting

- Long press M and ◀ key for 2s, prepare for setup system parameter: decode mode, 0/1-10V output, output brightness curve, default output level, automatic blank screen. short press M key to switch five item.
- Decode mode: short press ◀ or ▶ key to switch one-channel decode("d-1"), two-channel decode("d-2") or four-channel decode("d-4"). When set as 1 channel decode, the decoder occupy only 1 DMX address, and four channel output the same brightness of this DMX address.
- 0/1-10V output: short press ◀ or ▶ key to switch 0-10V("0-0") or 1-10V("1-0").
- Output brightness curve: short press ◀ or ▶ key to switch linear curve("C-L") or logarithmic curve("C-E").
- Default output level: set output level when no DMX input signal. short press ◀ or ▶ key to switch maintain DMX output("d-") or output default level ("d00" to "dFF", 0-100%), long press ◀ or ▶ key to change output default level.
- Automatic blank screen: short press ◀ or ▶ key to switch enable ("bon") or disable("boF") automatic blank screen.
- Long press M key for 2s or timeout 10s, quit system parameter setting.

DMX mode

- Short press M key, when display 001~512, enter DMX mode.
- Press ◀ or ▶ key to change DMX decode address(001~512), long press for fast adjustment.
- If there is a DMX signal input, will enter DMX mode automatically.
- DMX Dimming: Each DL DMX decoder occupy 4 DMX address when connecting the DMX console. For example, the defaulted start address is 1, their corresponding relationship in the form:



DMX mode (001~512)

DMX Console	DMX Decoder Output
CH1 0-255	CH1 0-10V
CH2 0-255	CH2 0-10V
CH3 0-255	CH3 0-10V
CH4 0-255	CH4 0-10V

Stand-alone RGB/RGBW mode

- Short press M key, when display P01~P24, enter stand-alone RGB/RGBW mode.
- Press ◀ or ▶ key to change dynamic mode number(P01~P24).
- Each mode can adjust speed and brightness. Long press M key for 2s, prepare for setup mode speed, brightness, W channel brightness. Short press M key to switch three item. Press ◀ or ▶ key to setup value of each item. Mode speed: 1-10 level speed(S-1, S-9, S-F). Mode brightness: 1-10 level brightness(b-1, b-9, b-F). W channel brightness: 0-255 level brightness(400-4FF). Long press M key for 2s, or timeout 10s, quit setting.
- Enter stand-alone RGB/RGBW mode only when DMX signal is disconnected or lost.



Stand-alone RGB/RGBW mode (P01~P24)



Speed (8 level)



Brightness (10 level, 100%)

RGB change mode list

No.	Name	No.	Name	No.	Name
P01	Static red	P09	7 color jump	P17	Blue purple smooth
P02	Static green	P10	Red fade in and out	P18	Blue white smooth
P03	Static blue	P11	Green fade in and out	P19	RGB+W smooth
P04	Static yellow	P12	Blue fade in and out	P20	RGBW smooth
P05	Static cyan	P13	White fade in and out	P21	RGBY smooth
P06	Static purple	P14	RGBW fade in and out	P22	Yellow cyan purple smooth
P07	Static white	P15	Red yellow smooth	P23	RGB smooth
P08	RGB jump	P16	Green cyan smooth	P24	6 color smooth

Stand-alone dimmer mode

- Short press M key, when display L-1~L-8, enter stand-alone dimmer mode.
- Press ◀ or ▶ key to change dimmer mode number(L-1~L-8).
- Each dimmer mode can adjust each channel brightness independently.
Long press M key for 2s, prepare for setup four channel brightness.
Short press M key to switch four channel(100~1FF, 200~2FF, 300~3FF, 400~4FF).
Press ◀ or ▶ key to setup brightness value of each channel.
Long press M key for 2s, or timeout 10s, quit setting.
- Enter stand-alone dimmer mode only when DMX signal is disconnected or lost.



Stand-alone dimmer mode
(L-1~L-8)

Restore factory default parameter

- Long press ◀ and ▶ key for 2s, restore factory default parameter, display "RES".
- Factory default parameter: DMX decode mode, DMX decode start address is 1, four channel decode, 0-10V output, linear brightness curve, output 100% level when no DMX input, RGB mode number is 1, dimmer mode number is 1, disable automatic blank screen.

Dimming Curve Setting

Linear dimming curve

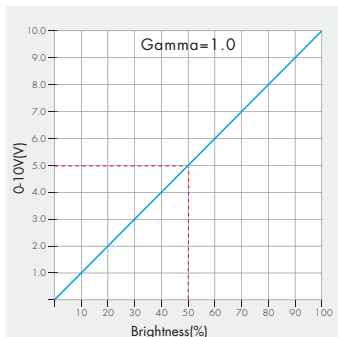

Logarithmic dimming curve

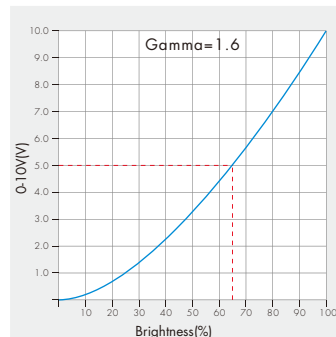

Malfunctions Analysis & Troubleshooting

Malfunctions	Causes	Troubleshooting
No light	1. No power. 2. Wrong connection or insecure.	1. Check the power. 2. Check the connection.
Wrong color	1. Wrong connection of 0-10V output wires. 2. DMX decode address error.	1. Reconnect 0-10V output wires. 2. Set correct decode address.