

Paste Anywhere Human Motion Sensor Switch head

- Paste Anywhere Human Motion Sensor Switch head, can be used with a variety of sensor controllers.
- Built-in 5.8GHz motion-detecting radar module detects human movement through wood, plastic, acrylic or thin non-metallic materials.
- 5VDC supply, high and low voltage level output.
- When detected human movement, the light will turn on; when human movement is not detected, the light will turn off after the delay is over.
- Detection distance: 0.5-5m, detection angle: 120°.
- 5 levels of delayed light off time can be set (10s, 30s, 60s, 180s, 300s).
- 4 levels of sensor distance can be set (5m, 3m, 1.5m, 0.5m).
- Ultra-thin design, no need to cut holes, random paste installation, can be hidden.
- Used for lighting cabinets, closets, bedrooms, staircases, corridors and more.



CE RoHS

Mechanical Structures

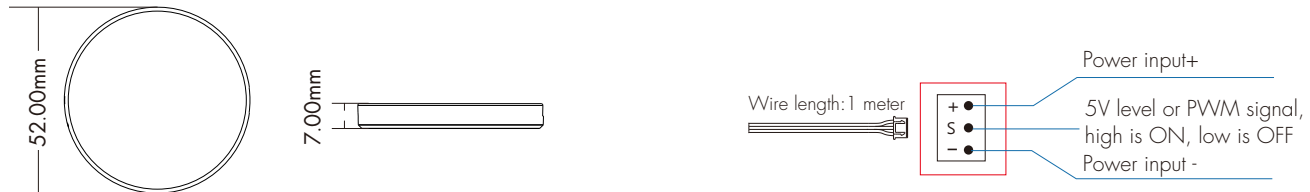

Set key and Indicator Function

When the light is on, the indicator is brighter; when the light is off, the indicator is less bright.

The factory default light off delay time is 30s and the sensing distance is 3m.

Please change the light off delay time and sensing distance according to the actual installation requirements by short press or long press the set key with the equipped pin.

Set the light off delay time:

Short press the set key to switch 5 levels of light off delay time in sequence.

When the light off delay time is set to 10s, the LED indicator blinks 1 time;

When the light off delay time is set to 30s, the LED indicator blinks 2 times;

When the light off delay time is set to 60s, the LED indicator blinks 3 times;

When the light off delay time is set to 180s, the LED indicator blinks 4 times;

When the light off delay time is set to 300s, the LED indicator blinks 5 times;

Note: When the sensor switch is powered up, the LED indicator will blink the corresponding number of times according to the current light off delay time setting value.

Set the sensor distance:

Long press the set key for 5-20s to set 4 levels of sensing distance in sequence.

Long press for 5s, set the sensor distance to 5m, the LED indicator blinks 1 time;

Long press for 10s, set the sensor distance to 3m, the LED indicator blinks 2 times;

Long press for 15s, set the sensor distance to 1m, the LED indicator blinks 3 times;

Long press for 20s, set the sensor distance to 0.5m, the LED indicator blinks 4 times;

Note: When long press, the LED indicator is off and will blink the corresponding number of times at 5s, 10s, 15s, and 20s moments.

Memory function:

After power failure and turn on again, the device automatically restores the setting parameters before power failure.

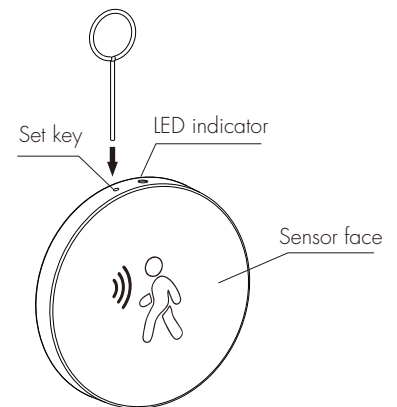

Sensor Switch Installation

Open installation:

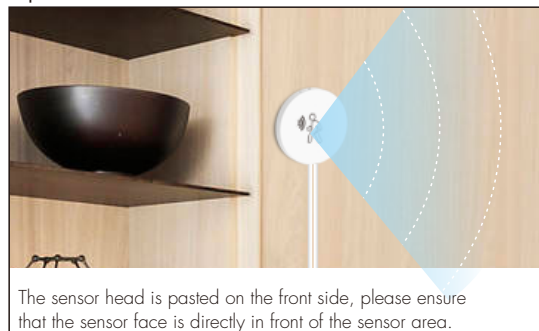

The sensor head is pasted on the front side, please ensure that the sensor face is directly in front of the sensor area.

Concealed installation:



The sensor switch is pasted on the back, please ensure that the sensor face is directly in front of the sensor area. Attach the human sensor logo on the front side.

Installation Precautions:

1. Please use 3M adhesive to install the sensor switch anywhere or on the back of non-metallic materials such as wood, plastic, glass, acrylic, etc.
2. The sensor switch is not affected by ambient temperature, humidity, light, etc., and has strong anti-interference capability.
3. The sensor head should be installed in the correct direction and angle.
 - When installing on the wall, it is recommended to install horizontally with a height of about 1.2-1.8m;
 - When installing on the ceiling, it is recommended to install vertically with a height of about 3m.
4. When installing multiple sensor switches, try to keep each sensor switch placed parallel to each other.
5. When installing, try to avoid facing large metal equipment or pipes to avoid signal interference.
6. Ensure that the sensor switch is not near or obstructed by high density materials (e.g., metal, concrete walls, etc.).
 - These materials can degrade or block the microwave signal and cause false triggering.

Sensor Head Application

Individual sensor application

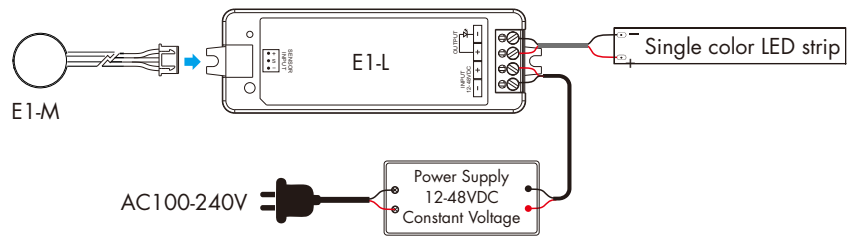
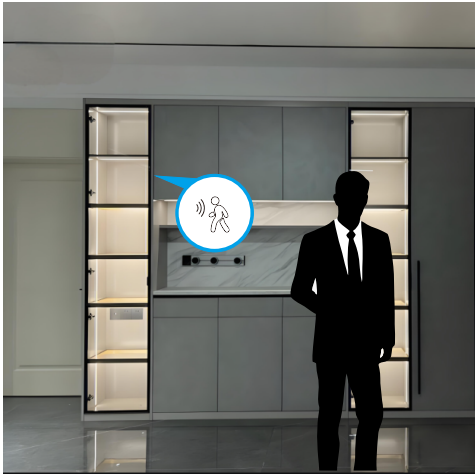

It is recommended to set the light off delay time of the sensor switch to 30s or 60s. Realize that the light on when people come, and the delayed light off when people leave.

Multiple sensors application

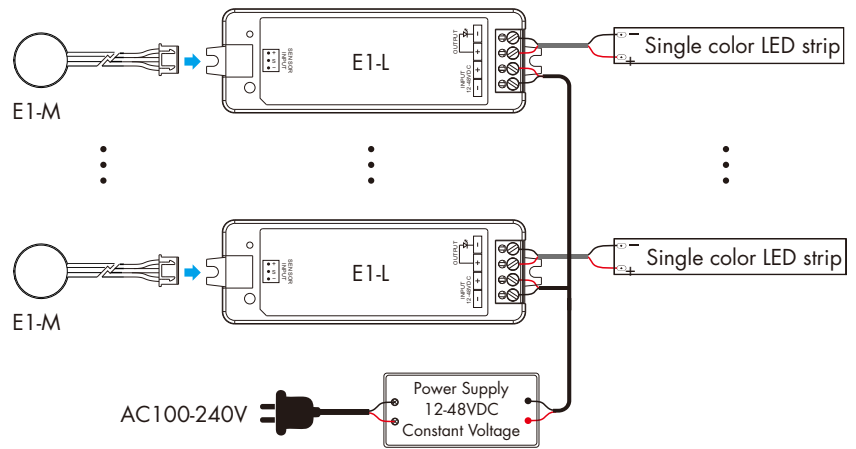

For multiple sensor applications, it is recommended to set the delayed light off time of all sensor switches to 10s. Realize sequential switching control of multiple lights in the direction of human movement.

Staircase lighting application

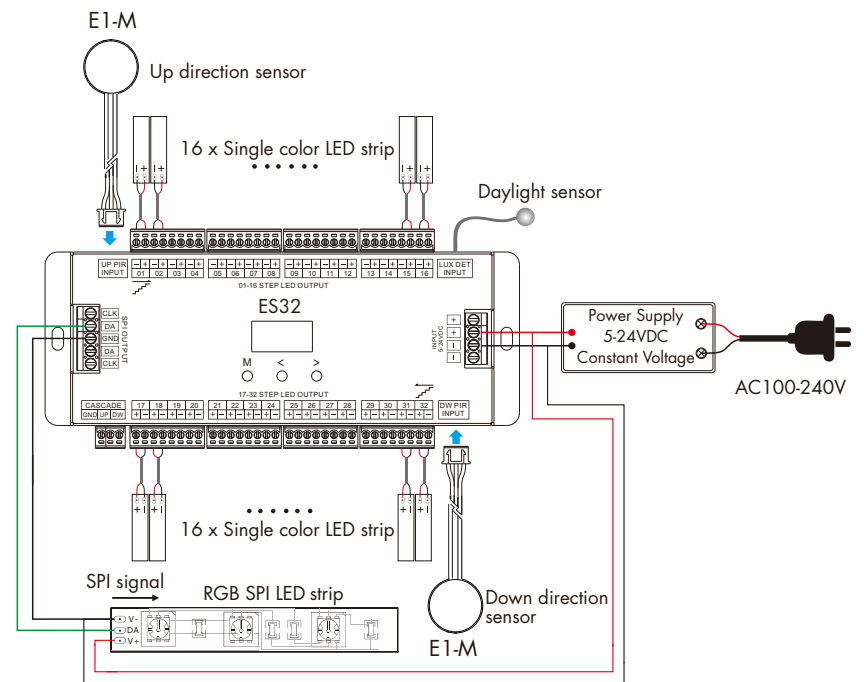
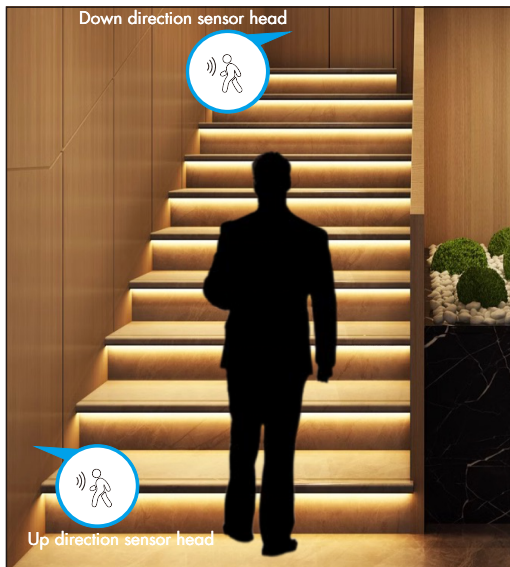

ES32 staircase light controller connects two human motion sensing heads that are mounted on the top and bottom of the stairs. Set both human motion sensing heads to a 10s delayed light off time, and then set longer delayed light off times (5 s, 10 s, 15 s, 20 s, 30 s, 1 min, 3 min, 5 min, 10 min) by the OLED screen. Realize sequential switching control of multi-step staircase lights.