

Dual Push Button WiFi SPI LED Controller

- Dual push button input RGB or white light SPI LED controller, Tuya smart APP cloud control.
- Voice control, support for Amazon Alexa, Google Assistant, Tmall Genie and Xiaodu smart speakers.

- Two groups same SPI(TTL) signal output, drive 28 kinds IC digital RGB or white LED strip, IC type and R/G/B order can be set.
Compatible ICs:

TM1804, TM1809, TM1812, UCS1903, UCS1909, UCS1912, UCS2903, UCS2909, UCS2912, WS2811, WS2812, TM1829, TM1914A, GW6205, GS8206, GS8208, LPD6803, LPD1101, D705, UCS6909, UCS6912, LPD8803, LPD8806, WS2801, WS2803, P9813, SK9822, SM16703P.

- When applied to stair light, supports four output modes: color flow, white flow, color step, white step.
- Sequential switching control is realized when multiple SPI controllers are connected to a single self-resetting push switch button.
- Multiple light colors and change types are selectable with adjustable speed and brightness.
- APP painted segment color mixing: full color filling, color pencil segment painting, eraser segment light off.
- APP custom rich dynamic effects: 44 default and 10+ custom dynamic scenarios, 16 variations.
- 3 APP music rhythms.

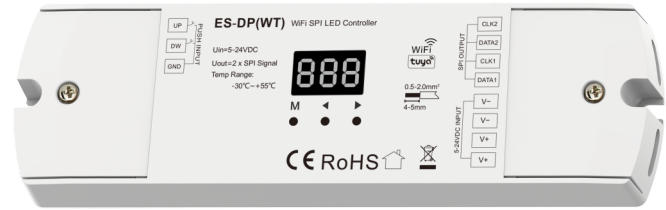

CE RoHS

Technical Parameters

Input and Output		Environment		Safety and EMC	
Input voltage	5-24VDC	Operation temperature	Ta: -30°C ~ +55°C	EMC standard (EMC)	ETSI EN 301 489-1 V2.2.3 ETSI EN 301 489-17 V3.2.4
Input current	1.5A	Case temperature (Max.)	Tc: +65°C	Safety standard	EN 62368-1:2020+A11:2020
Output signal	2 X SPI(TTL)	IP rating	IP 20	Certification	CE, EMC
Pixel number	Max 960	Package		Warranty	
Input signal	Push button +WiFi	Size	L175 x W54 x H27mm	Warranty	5 years
		Gross weight	0.127kg		

Mechanical Structures and Installations

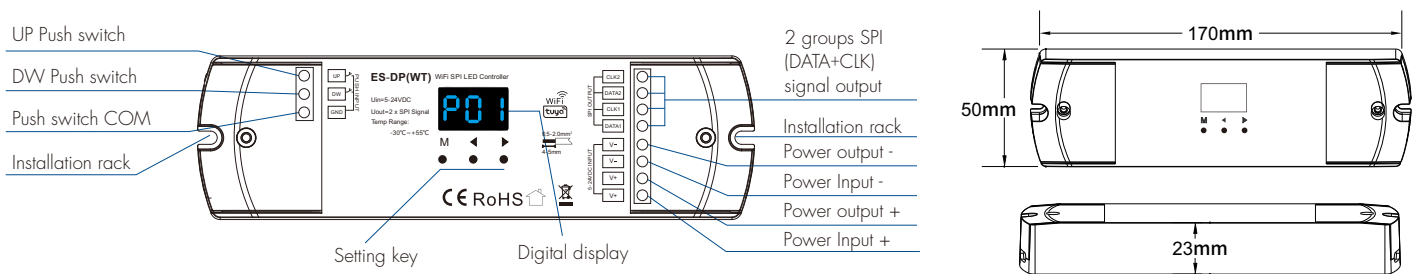

System wiring

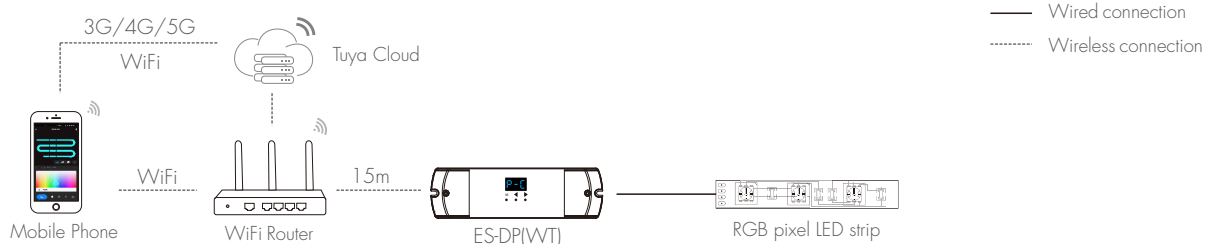

Note:

1. The above distance is measured in spacious (no obstacle) environment, please refer to the actual test distance before installation.
2. Please check if the WiFi router net in 2.4G band, the 5G band is not available, and do not hide your router network.
3. Please keep the distance between ES-DP(WT) devices and router close, and check the WiFi signals.
4. WiFi signal strength detection: open the main interface of social security, click enter the device interface, click "check device network" for testing.

Wiring Diagram

1. One controller connected to two self-resetting switches for up/down switch control

(1) Color / white light flow control stair light application

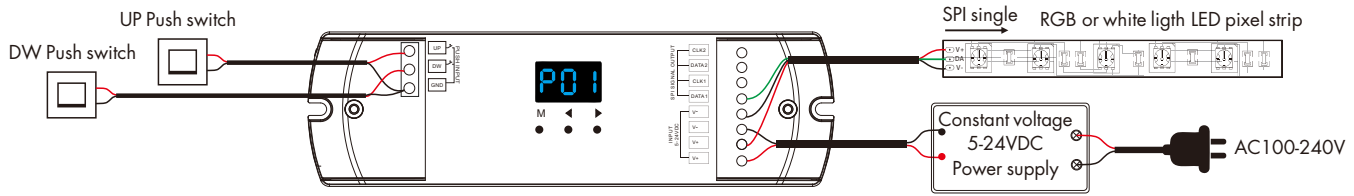

(2) Color / white light step control stair light application

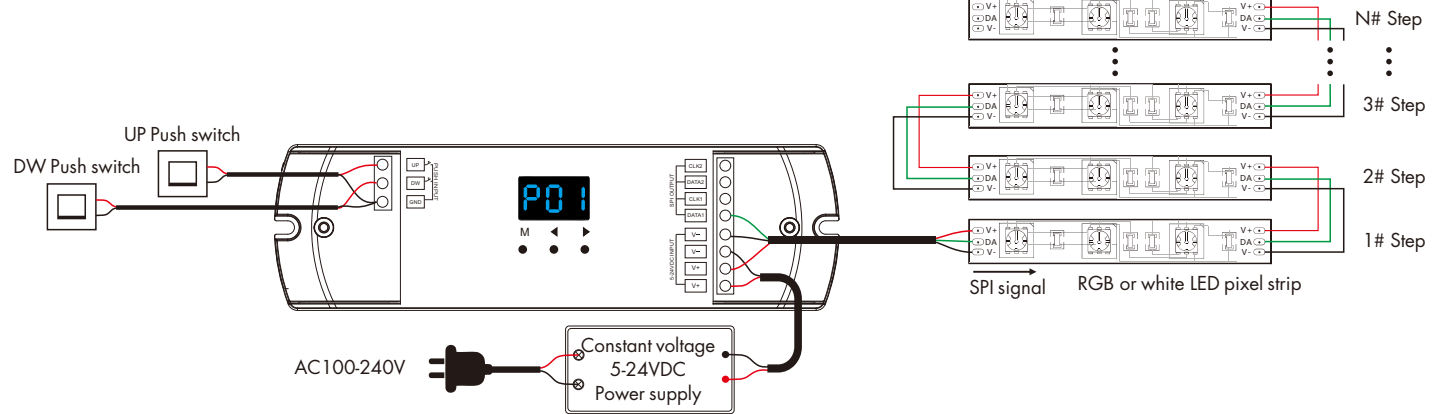

- Connect two push switches for manual control of stair lights.
The UP push switch is installed at the bottom of the stairs; the DW push switch is installed at the top of the stairs.
- Set the self-reset push switch to 0s for both light on delay and light off delay.
- Short press the self-reset push switch to turn on the light, display the current light effect mode; short press the self-reset push switch again, turn off the light, display "OFF".
- Long press the UP self-reset push switch to adjust the brightness, range 10-100%, digital tube display "b10"-"bFF".
(Note: The DW self-reset push switch does not have the function of adjusting the brightness.)

2. Multiple controllers connected to a self-resetting switch for sequential switch control

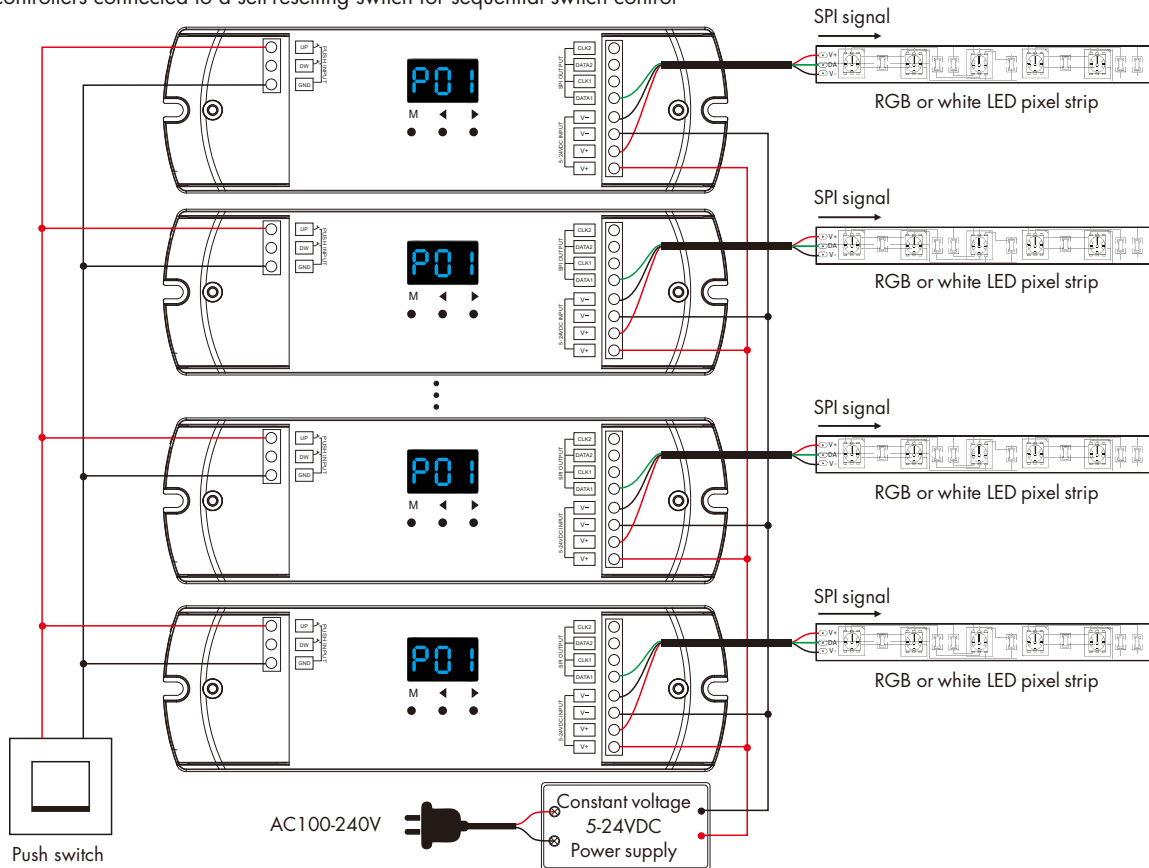

- Connect a self-reset push switch to the UP switch port (or DW switch port, taking care not to mix them) of multiple controllers at the same time.
- Set the self-reset push switch light on/off delay time of multiple controllers to incremental or decremental values, for example:
set 1-4# controllers' push switch light on delay time to 0s, 1s, 2s, 3s respectively, and push switch light off delay time to 3s, 2s, 1s, 0s respectively.
In this way, 1-4# controllers will turn on the lights in the same order, and turn off the lights in the reverse order.
- Short press the self-reset push switch to turn on the lights sequentially. during the delayed light on time, digital display "don".
When the light on, display the current light dynamic mode.
Short press the self-reset push switch again to turn off the lights sequentially. during the delayed light off time, digital display "doF".
When the lights off, digital display "OFF".
- When the lighting effects of multiple controllers are confused, it can be quickly restored by double-click the self-reset push switch.

Installation Precautions:

1. If the SPI LED strip is a single-wire control method, the DATA and CLK signal line outputs of the controller are same, and one controller can connect four LED strips.
2. If the SPI LED strip is a dual wire control method, one controller can connect two LED strips.
3. When the SPI strip load does not exceed 1.5A, the same power supply can simultaneously power the ES-DP(WT) controller and the SPI strip at the same time.
When the load on the SPI strip exceeds 1.5A, separate power supplies are required for the ES-DP(WT) controller and the SPI strip.
Only DATA and GND signal lines are connected between ES-DP(WT) controller and SPI strip.
4. The color or white light flow mode can control up to 960 pixel points of SPI strip.
5. The color or white light step mode defaults to 30 steps with 10 pixels per step. the step number x pixel length per step must ≤ 960 .

Parameters Setting

1. Long press the M and ◀ key for 2s simultaneously, enter the light parameters setting state: set the light type, LED strip connection mode (flow or step) pixel length, step number, light on/off mode, self-reset push switch turn on or off light delay time.

(1) Light type setting

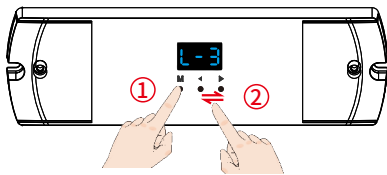

- 3-bead white light:** 1 pixel with 3 same data, control 3-bead white LED, display "L-1".
1-bead white light: 1 pixel with 1 data, control 1-bead white LED, display "L-2".
RGB color light: 1 pixel with 3 data, control one R/G/B LED, display "L-3".

- ① Short press M key enter light type setting interface;
- ② Short press ◀ or ▶ key to switch light type.

(2) LED strip connection mode setting

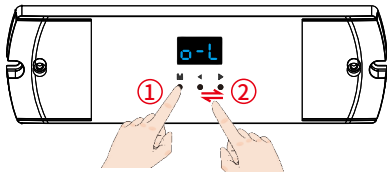

- Flow mode:** Straight line digital pixel LED strip connection mode, display "o-L".
Step mode: Z-shape digital pixel LED strip connection mode, display "o-S".

- ① Short press M key enter LED strip connection mode setting interface;
- ② Short press ◀ or ▶ key to switch LED strip connection mode.

(3) Pixel length setting

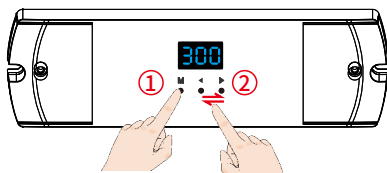

- Pixel length:**
For color or white flow mode, set the number of pixel points, the range is 032-960, display "032"-960".

- ① Short press M key enter pixel length setting interface;
- ② Short press ◀ or ▶ key to set the pixel length.

(4) Step number and step pixel length setting

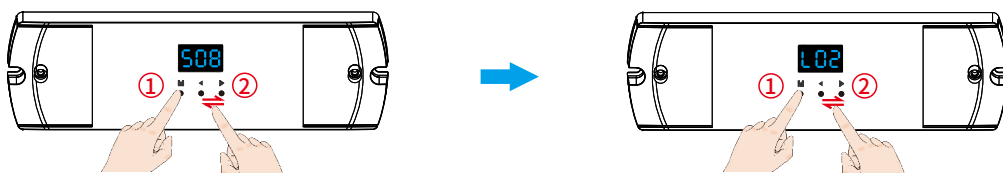

- ① Short press M key enter step number setting interface;
- ② Short press ◀ or ▶ key to set the step number.

- ① Short press M key enter step pixel length setting interface;
- ② Short press ◀ or ▶ key to set the step pixel length.

Step numbers and step pixel length:

For color or white step mode, set the number of steps and pixel dot number of each step.

Step number: the range is 8-99, display "S08"-S99";

Pixel dot number of each step: the range is 2-99, display "L02"-L99".

the step number x pixel dot number of each step number must ≤ 960 .

(5) Light on/off mode setting (Table 1)

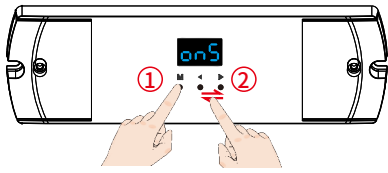

- ① Short press M key enter light on setting interface;
 ② Short press ◀ or ▶ key to switch two light on mode:
 Sequential light on:
 Light turn on sequentially from the beginning to the end, display "onS" .
 Synchronized light on:
 Light turn on synchronously, display "onC" .

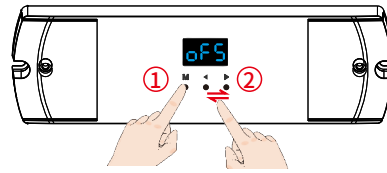

- ① Short press M key enter light off setting interface;
 ② Short press ◀ or ▶ key to switch three light off mode:
 Sequential light off:
 Light turn off sequentially from the beginning to the end, display "oFS" .
 Sequence light off in reverse:
 Light turn off sequentially from end to beginning, display "oFb".
 Synchronized light off:
 Light turn off synchronously, display "oFC" .

List of ways to turn on/off light combinations:

Display	Name
onS + oFS	Sequential light on, sequential light off
onS + oFb	Sequential light on, sequential reverse light off
onS + oFC	Sequential light on, synchronized light off
onC + oFS	Synchronized light on, sequential light off
onC + oFb	Synchronized light on, sequential reverse light off
onC + oFC	Synchronized light on, synchronized light off

(Table 1)

(6) Self-reset push switch turn on or off light delay time setting

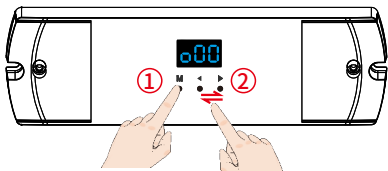

- ① Short press M key enter push switch turn on light delay time setting interface;
 ② Short press ◀ or ▶ key to set the delay time.

Self-reset push switch turn on light delay time:

Setting range 0-15.5s, the smallest unit 0.5s, display "o00"-o95"-oF5",
 A-F indicates that 10-15s.
 Setting 0s means turn on light immediately.

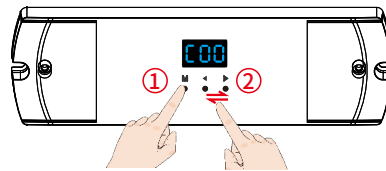

- ① Short press M key enter push switch turn off light delay time setting interface;
 ② Short press ◀ or ▶ key to set the delay time.

Selfreset push switch turn off light delay time:

Setting range 0-15.5s, the smallest unit 0.5s, display "c00"-c95"-cF5",
 A-F indicates that 10-15s.
 Setting 0s means turn off light immediately.

2. Long press the M and ▶key for 2s simultaneously, enter the LED strip parameters setting state: set the chip type, RGB color order.

(1) Chip type setting

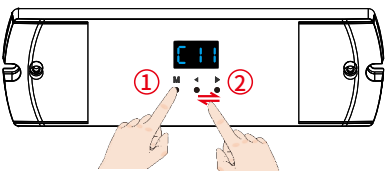

- ① Short press M key enter the chip type setting interface;
 ② Short press ◀ or ▶ key to switch chip type (Table 2).

(2) RGB color order setting

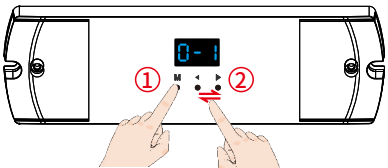

- ① Short press M key enter the RGB order setting setting interface;
 ② Short press ◀ or ▶ key to switch R/G/B order (Table 3).

3. Quit the parameter setting

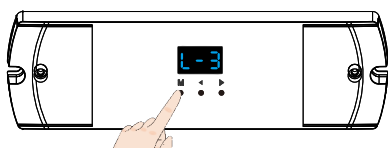

Long press the M key for 2s or wait for 15s, quit the parameter setting state.

LED strip IC types list:

No.	IC type	Compatible IC type	Output signal
C11	TM1809	TM1804, TM1812, UCS1903, UCS1909, UCS1912, UCS2903, UCS2909, UCS2912, WS2811, WS2812, SM16703P	DATA
C12	TM1829		DATA
C13	TM1914A		DATA
C14	GW6205		DATA
C15	GS8206	GS8208	DATA
C21	LPD6803	LPD1101, D705, UCS6909, UCS6912	DATA, CLK
C22	LPD8803	LPD8806	DATA, CLK
C23	WS2801	WS2803	DATA, CLK
C24	P9813		DATA, CLK
C25	SK9822		DATA, CLK

(Table 2)

LED strip RGB color order:

R/G/B order	RGB	RBG	GRB	GBR	BRG	BGR
Digital display	0-1	0-2	0-3	0-4	0-5	0-6

(Table 3)

Light effect settings

(1) Light color setting

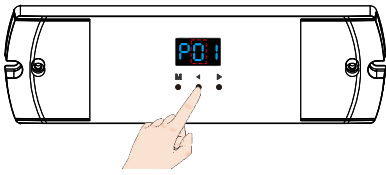

Short press ◀ key to switch 10 light colors in sequence (Table 4).

(2) Light change type setting

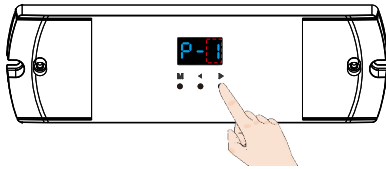

Short press ▶ key to switch 5 light change types in sequence (Table 5).

(3) Light effect parameter setting (i.e., speed, brightness, Self-defined R/G/B color)

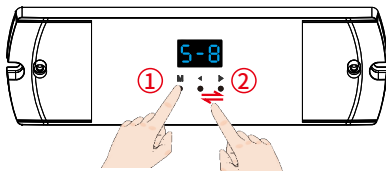

① Short press M key to switch three parameter items;

② Short press ◀ or ▶ key to adjust the value of each parameter item.

Speed, brightness, and self-defined R/G/B color parameter value description:

Speed: 1-8 levels adjustable, display "S-1"-"S-8", S-8 is the maximum speed.

Brightness: 1-10 level adjustable, display "b10"-"bFF", bFF means maximum brightness 100%.

Self-defined R/G/B color: 0-255 (00-FF) adjustable.

R channel displays "100"-"1FF"; G channel displays "200"-"2FF"; B channel displays "300"-"3FF".

(4) Quit light effect parameter setting

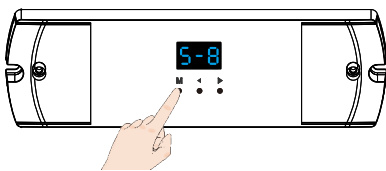

Long press the M key for 2s or wait for 15s, quit the light effect parameter setting state.

Note:

1. White flow / white step mode does not support self-defined R/G/B color function.
2. For color flow / color step mode, the light color and light change type are combined to form 50 kinds of light effects.
3. For color flow / color step / white flow / white step mode, can be adjusted in speed and brightness.

Factory Default Parameter setting

- Long press ◀ and ▶ key for 2s simultaneously, restore factory default parameters, display "RES".
- Factory default parameters: RGB color light flow output, 300 pixels, sequential light on, sequential light off, push switch turn on delay and turn off delay is 0s, chip type TM1809, RGB order.

Tuya smart APP network connection

Long press M, ◀ and ▶ key for 2s simultaneously, clear previous network connection, enter Smart config mode, the digital tube flashes "-C-". In Tuya smart APP, you can find ES-WT device. If Tuya smart APP network connection succeed, the digital tube will stop flash.



Color Flow/Color Step mode, the digit shows P01~P95.



White Flow/White Step mode, the digit shows P-1~P-5.



Tuya APP customized lighting effect, digital tube display: P-C

Color type (2nd digit):

NO.	Name
0	Rxxx Gxxx Bxxx (User define)
1	Red
2	Orange
3	Yellow
4	Green
5	Cyan
6	Blue
7	Purple
8	R/G/B 3 color
9	7 color

(Table 4)

Color/white light change type (3rd digit):

NO.	Name
1	Flow
2	Chase
3	Float
4	Trail
5	Trail+black section

(Table 5)

LED strip length, chip type and color sequence can be set either through the controller buttons or through the Tuya smart APP interface.

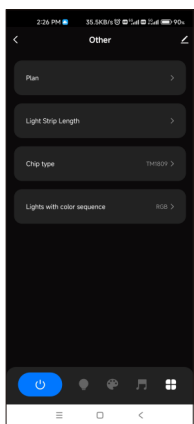

Other interface
For the first time use, set LED strip length, chip type and color sequence.

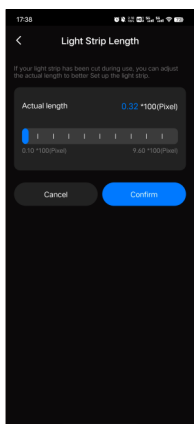

Light Strip Length interface
Strip length setting:
Select the appropriate number of pixels according to the actual length of the strip,
flow output mode: 32-960.
Step output mode: 16-960.

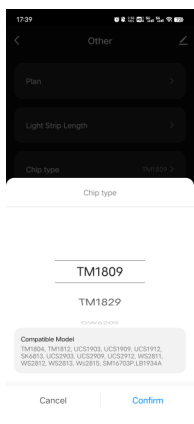

Chip type interface
Select the corresponding chip according to the chip type of the light strip and list of chip types supported by the controller.

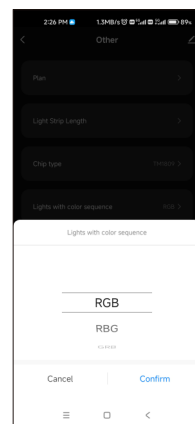

Lights with color sequence interface
Select the corresponding R/G/B sequence according to the color sequence of the light strip. (RGB, RBG, GRB, GBR, BRG, BGR)

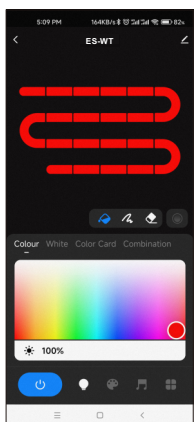

Colour:
Touch the color rectangle to adjust color and saturation.
Touch the brightness slide to adjust brightness.

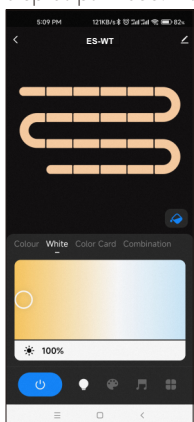

White:
Touch the color rectangle to adjust color temperature.
Touch the brightness slide to adjust brightness.

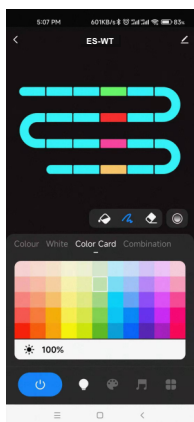

Color Card:
Touch the color card array to select many different colors.
Touch the brightness slide to adjust brightness.

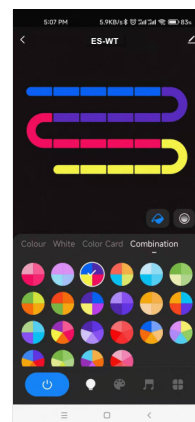

Combination:
Select a proportional distribution of multi-color circle, evenly distribute these colors on the LED strip.



Color Fill: Change the color of the full segment of the LED strip.



Eraser: Erase the color of a single segment of the LED strip, i.e., turn off the light.



Color pen: change the color of a single segment of the LED strip.



Color transition: When there are multiple colors in the LED strip, you can set to turn on or off the color segment gradient transition.

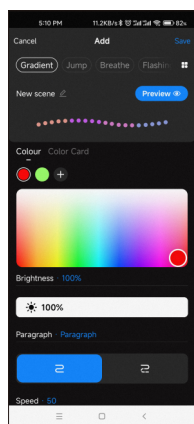
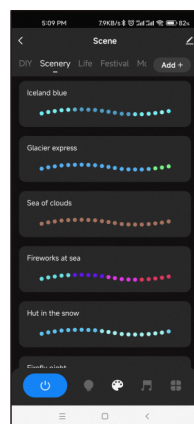

Scene interface
44 predefined scenarios and 10+ custom dynamic scenarios selectable.
The custom scenarios can select 16 types variations (fade, jump, breath, flash, flow, rainbow, shooting star, pile-up, floating down, chasing light, floating, flashing, bouncing, shuttle, chaotic flashing, open and close), the 1-8 colors, full or segment control, forward or reverse motion direction, adjustable brightness and speed.

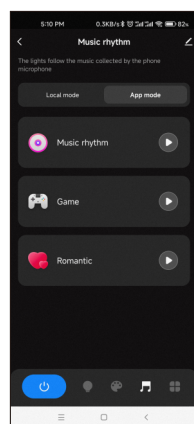
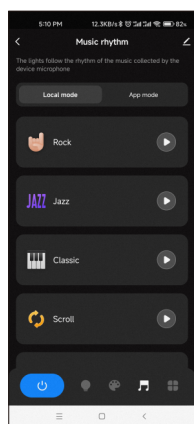

Music rhythm interface
6 local music modes (rock, jazz, classical, rolling, energy, spectrum) selectable.
3 APP modes (music rhythm, game, romance) selectable.
Adjustable sensitivity of the received sound.
The light follows the rhythm according to the music collected by the phone microphone.
Note: the controller only supports App mode.