

F1-M(WT)+RC1

WiFi & Infrared remote LED Dimmer

- WiFi & Infrared remote control 1 channels constant voltage single color LED dimmer.
- DC power socket input, 5A output, output connects with 5 meters RGB LED strip.
- Tuya Smart APP cloud control, support on/off, brightness adjust, delay turn on/off light, timer run, scene edit function.
- Voice control, support for Amazon Alexa, Google Assistant, Tmall Genie and Xiaodu voice assistant.
- Adjust the brightness by IR remote or SET key.
- 4096 levels dimming smoothly without any flash.
- Logarithmic dimming curve.



CE RoHS 

Technical Parameters

Input and Output		Dimming data		Safety and EMC	
Input voltage	5-24VDC	Input signal	WiFi + IR + key	EMC standard (EMC)	ETSI EN 301 489-1 V2.2.3 ETSI EN 301 489-17 V3.2.4
Output voltage	5-24VDC	Control distance	10m(Barrier-free space)	Safety standard	EN 61348-1:2015+A1:2021 EN 61348-2-13:2014+A1:2017
Output current	Max. 5A	Dimming gray scale	4096 level	Certification	CE, EMC
Output power	25W@5V 60W@12V 120W@24V	Dimming range	10-100%		
		Dimming curve	Logarithmic		
		PWM Frequency	2000Hz (default)		
Environment		Warranty		Package	
Operation temperature	Ta: -20°C ~ +50°C	Warranty	5 years	Size	L110x W57x H32mm
Case temperature (Max.)	Tc: +85°C	Protection	Over heat	Gross weight	0.090kg

Mechanical Structures and Installations

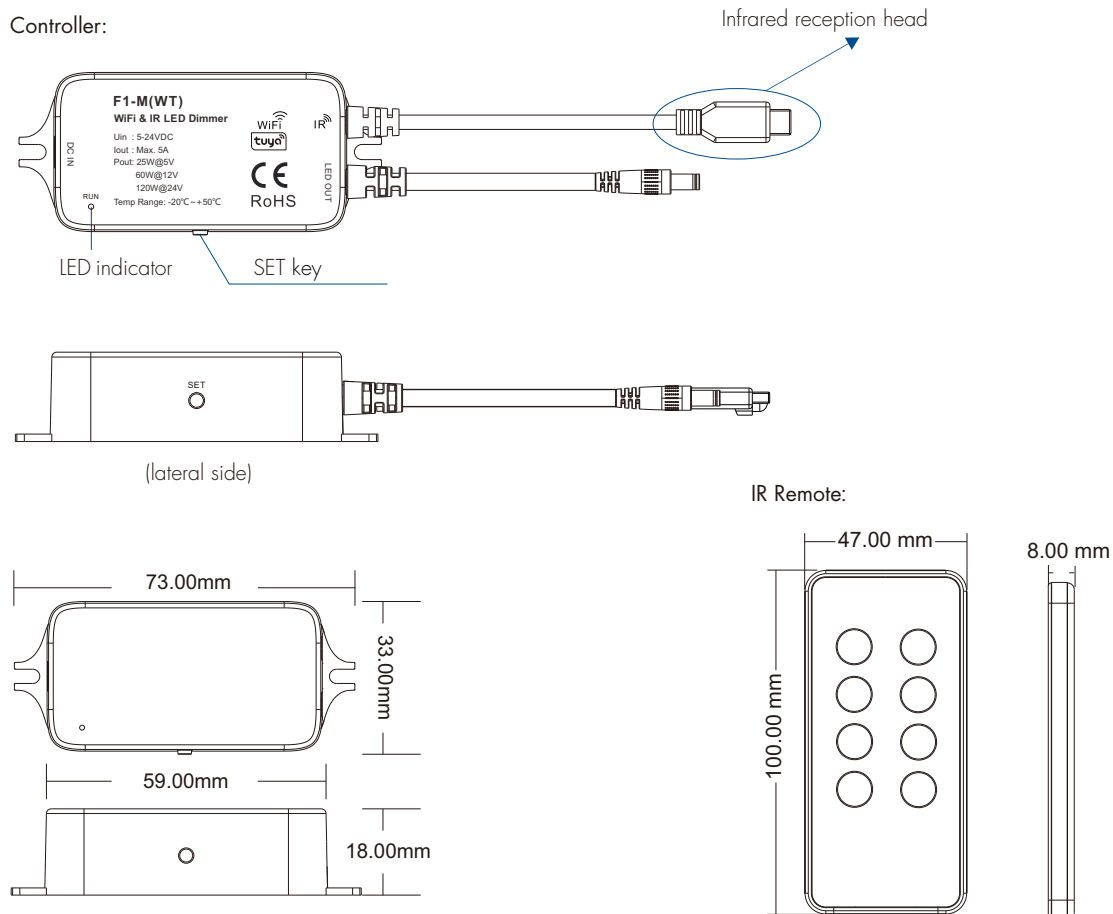

Wiring Diagram

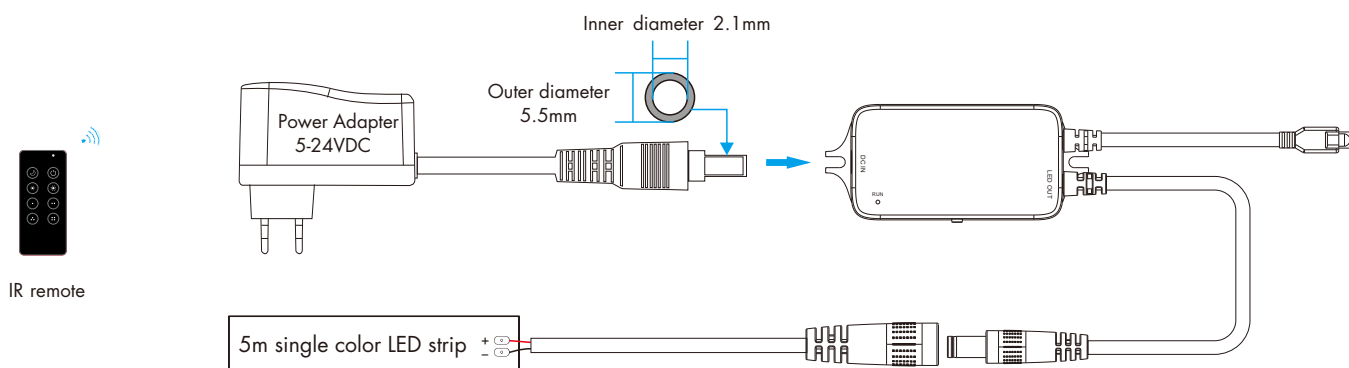

System Wiring

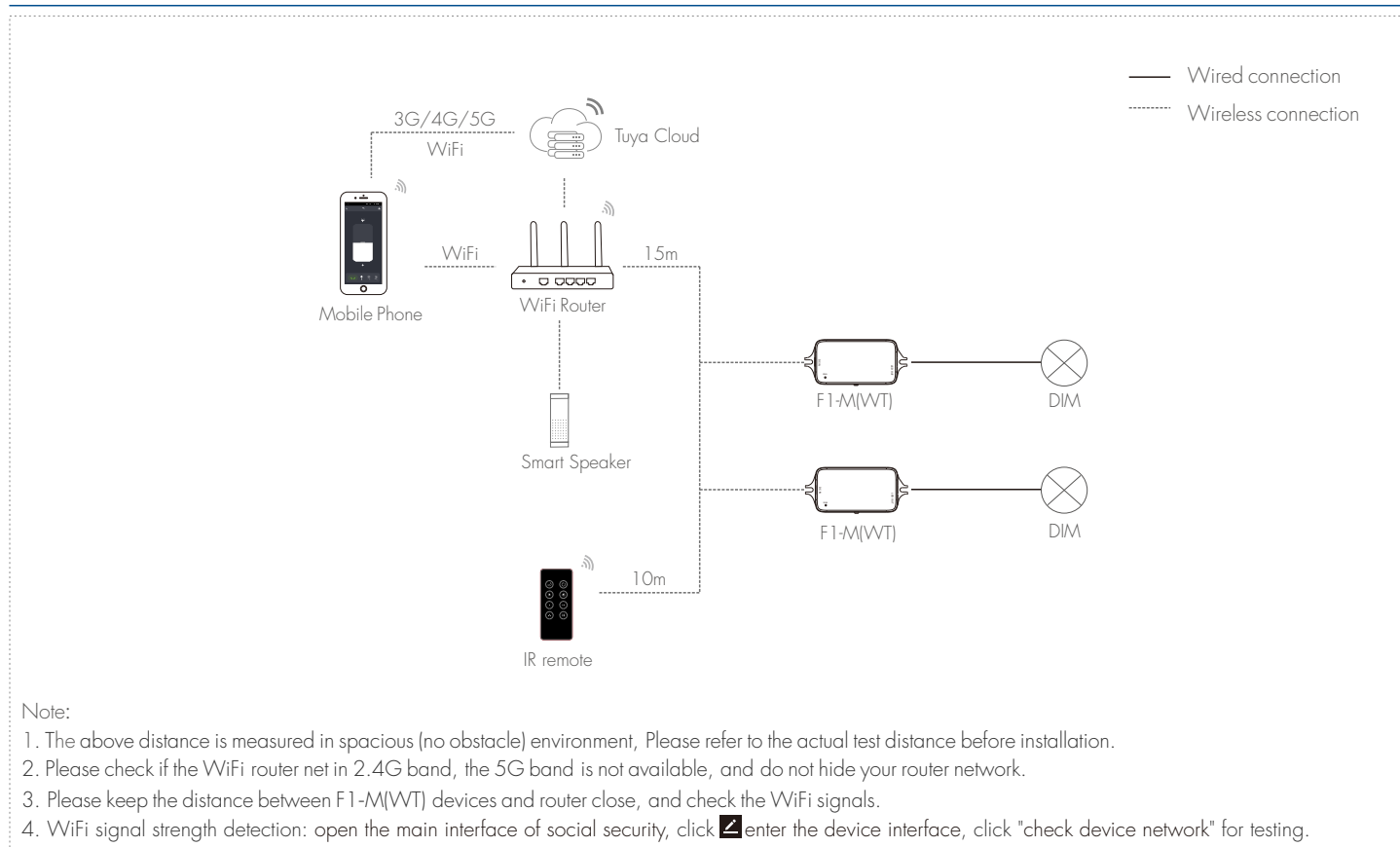

Key Function of IR Remote

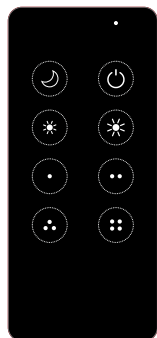

- : Short press turn on/off the light.
- : Night light function, 10% brightness with short press.
- : Increase brightness, Short press 10 levels, long press 1-6s for continuous 256 levels adjustment.
- : Decrease brightness, Short press 10 levels, long press 1-6s for continuous 256 levels adjustment.
- Short press to select each of the four brightness levels: 25%, 50%, 75%, 100%.

Notes:

1. IR remote control does not need to be paired and can be controlled directly.
2. When the remote control is far away, using infrared remote control, you need to align with the infrared sensor head.

SET Key Function of Dimmer

Short press: sequentially switch 5 levels of light brightness (10%, 25%, 50%, 75%, 100%).

Long press (1-6s): Step-less dimming, with every other long press, the light level goes to the opposite direction, dimming range 10%-100%.

Tuya Smart APP Network Connection

Please download the corresponding Tuya Smart/Smart life APP according to your region.

Three methods to clear the previous network connection, enter WiFi Smart config mode, and the output LED will flash 10 times.

1. Long press the SET key for 12s.
2. Double click the SET key within 10s of the dimmer powering up.
3. Dimmer power on and off for 5 consecutive times.



Smart life APP



Tuya Smart APP

In Tuya Smart APP, you can find DIMc device.

If Tuya Smart APP network connection succeed, the output LED will stop flash.

Tuya Smart APP Interface

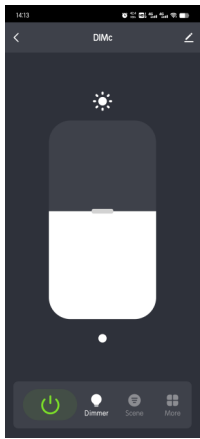

White interface

Touch brightness slide to adjust brightness.

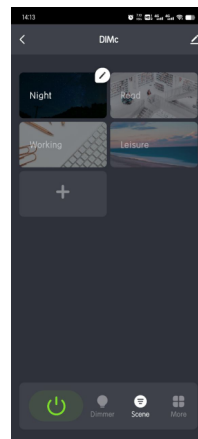

Scene interface

The 1-4 scene is static color.
the inner color of these scene can be editable.

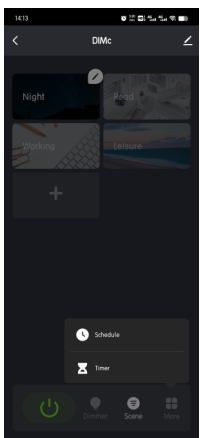

Timer, Schedule

The Schedule key can add multiple timers to turn on or turn off light according to different time periods.

The Timer key can turn on or turn off light in the next 24 hours.

Dimming Curve

