

M5(WT)

WiFi + RF

WiFi & RF LED Controller

- WiFi & RF 6 button RGB, RGBW or RGB+CCT LED controller with 5 channel constant voltage output.
- 6 buttons operation with on/off, adjust brightness, color temperature and RGB color, change dynamic mode and speed.
- Set up 5 light type by button: RGB, RGBW, RGB+W, RGB+CCT or RGB+CCT.
- Tuya smart APP cloud control, support on/off, RGB color, color temperature and brightness adjust, delay turn on/off light, timer run, scene edit and music play function.
- Voice control, support for Amazon Alexa, Google Assistant, Tmall Genie and Xiaodu voice assistant.
- Match with RF 2.4G single zone or multiple zone RGB, RGBW, RGB+CCT remote control optional.
- One RF controller accept up to 10 remote control.
- 4096 levels 0-100% dimming smoothly without any flash.
- Built in 10 dynamic modes, include jump or gradual change style.



CE RoHS emc RED

Technical Parameters

Input and Output		Dimming data		Safety and EMC	
Input voltage	12-24VDC	Input signal	WiFi + RF 2.4GHz	EMC standard(EMC)	ETSI EN 301 489-1 V2.2.3 ETSI EN 301 489-17 V3.2.4
Output voltage	5x(12-24)VDC	Control distance	30m (Barrier-free space)	Safety standard	EN 61348-1:2015+A1:2021 EN 61348-2-13:2014+A1:2017
Output current	5CH,3A/CH	Dimming gray scale	4096 (2^12) levels	Radio Equipment(RED)	ETSI EN 300 328 V2.2.2
Output power	5x(36-72)W	Dimming range	0-100%	Certification	CE, EMC, RED
Output type	Constant voltage	Dimming curve	Logarithmic	Environment	
Warranty and Protection		PWM Frequency	2000Hz (default)	Operation temperature	Ta: -20°C ~ +55°C
Warranty	5 years	Package		Case temperature (Max.)	Tc: +85°C
Protection	Reverse polarity, Short circuit Over-heat, Over-load	Size	L162 x W42 x H26mm	IP rating	IP20
		Gross weight	0.091kg		

Mechanical Structures and Installations

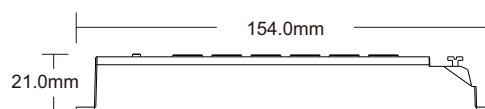
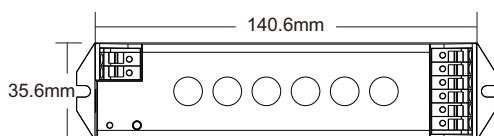
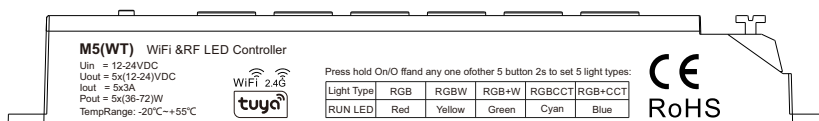
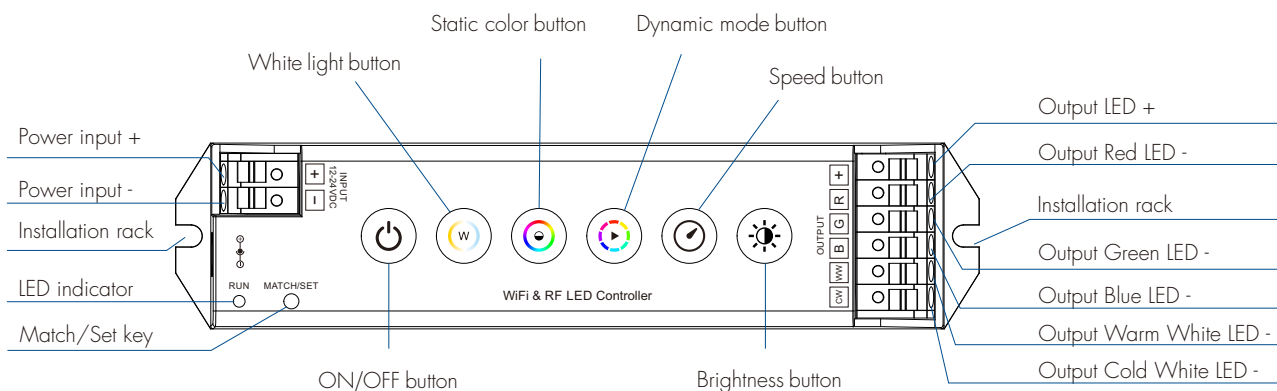

System wiring

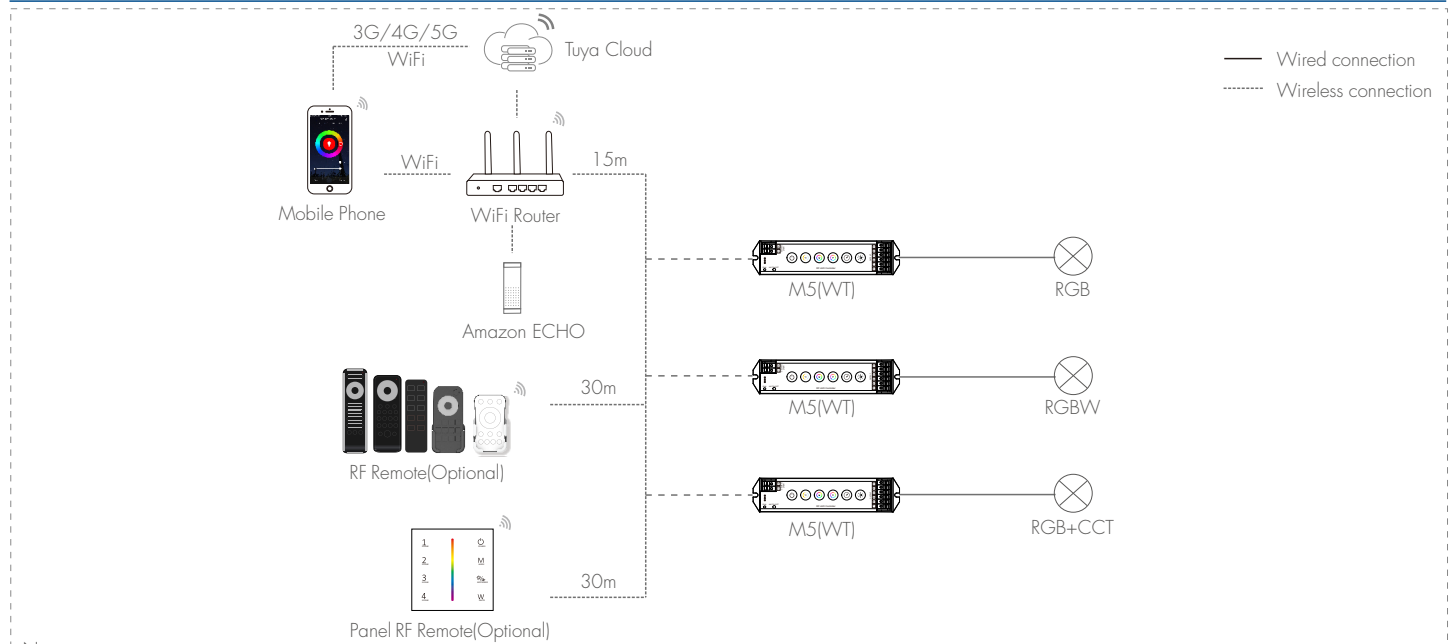

Note:

1. The above distance is measured in spacious (no obstacle) environment, Please refer to the actual test distance before installation.
2. Please check if the WiFi router net in 2.4G band, the 5G band is not available, and do not hide your router network.
3. Please keep the distance between M5(WT) devices and router close, and check the WiFi signals.
4. WiFi signal strength detection: open the main interface of social security, click enter the device interface, click "check device network" for testing.

Wiring diagram

• For RGB

Press and hold and button for 2s, set to RGB light type, LED indicator shows red.

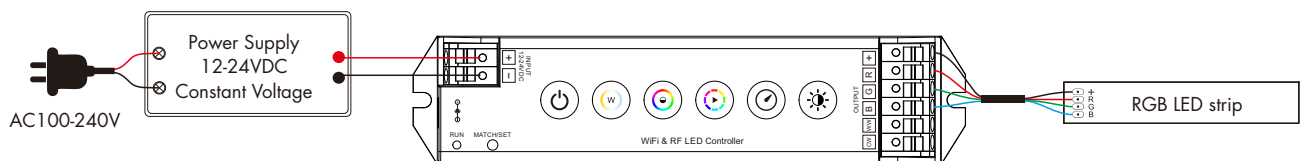

• For RGBW

Press and hold and button for 2s, set to RGBW light type (RGB channel and W channel outputs cannot be turned on at the same time), LED indicator shows yellow.

Press and hold and button for 2s,

set to RGB+W light type (RGB channel and W channel outputs can be turned on at the same time), LED indicator shows green.

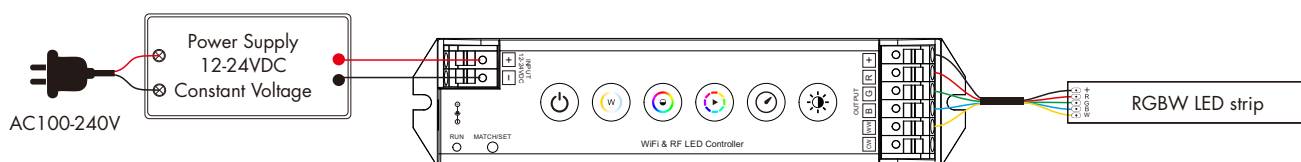

• For RGB+CCT

Press and hold and button for 2s,

set to RGB+CCT light type (RGB channel and WW/CW channel outputs cannot be turned on at the same time), LED indicator shows cyan.

Press and hold and button for 2s,

set to RGB+CCT light type (RGB channel and WW/CW channel outputs can be turned on at the same time), LED indicator shows blue.

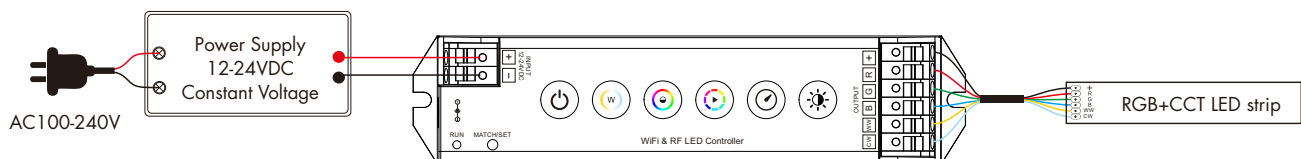

Tuya smart APP network connection

Please download the corresponding Tuya smart/Smart life APP according to your region.

Press and hold Match/Set key for 2s, push twice Match/Set key fastly, or set five light types by buttons:
Clear previous network connection, enter WiFi Smart config mode, the purple LED indicator flash fastly, the output LED will flash 10 times.

Press and hold Match/Set key for 5s:

Clear previous network connection, enter AP config mode, the purple LED indicator flash slowly.
If WiFi Smart config failed, please try AP config.

Repeat power on and off for 5 consecutive times, also clear previous network connection, enter Smart config mode, the output LED will flash 10 times.

In Tuya APP, automatically add devices, you can find RGB+CCT device (or other RGB or RGBW).

If Tuya smart APP network connection succeed, the RUN LED indicator will stop flash purple, and turn corresponding light type color (Red: RGB, Yellow: RGBW, Green: RGB+W, Cyan: RGB+CCT, Blue: RGB+CCT).



Smart life APP



Tuya Smart

Tuya smart APP interface and operation

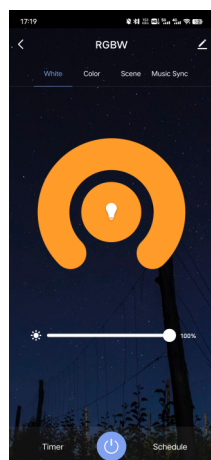

White interface

For RGB type:
Touch brightness slide, get RGB mixed white firstly, then to adjust white brightness.

For RGBW,RGB+W type:
Touch brightness slide, adjust white channel brightness.

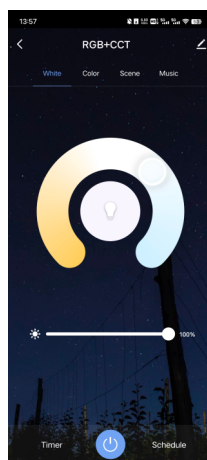

Color temperature interface

For RGB+CCT,RGB+CCT type:
Touch color wheel to adjust color temperature,
Touch brightness slide to adjust white brightness.

Note:for RGB+CCT type,
When touch color wheel to adjust color temperature,
RGB channel will turn off automatically.

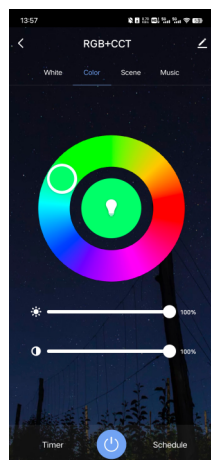

Color interface

For RGB,RGBW,RGB+W,RGB+CCT,RGB+CCT type:
Touch color wheel to adjust static RGB color.
Touch brightness slide to adjust color brightness.
Touch saturation slide to adjust color saturation,
namely gradient from the current color to white (RGB mixed).

Note:for RGBW,RGB+CCT type,
When touch color wheel to adjust static RGB color,
W channel or CCT channel will turn off automatically.

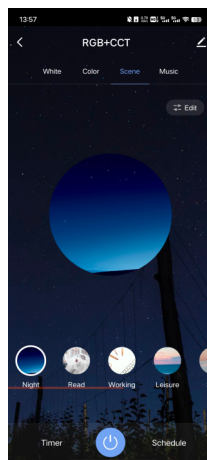

Scene interface

The 1-4 scene is static color.
the inner color of these scene can be editable.

The 5-8 scene is dynamic mode ,
such as green fade in and fade out,
RGB jump, 6 color jump, 6 color smooth.

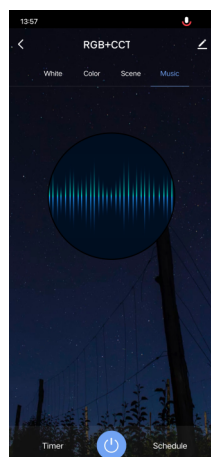

Music, Timer, Schedule

The music play can use smart phone music player or micro-phone as music signal input.

The Timer key can turn on or turn off light in the next 24 hours.

The Schedule key can add multiple timers to turn on or turn off light according to different time periods.

Button Function



: Turn on/off the light.



: Adjust the color temperature or white light brightness.

For RGB light type, short press to switch five levels color temperature (RGB mix, warm white - neutral white - cold white sequence); long press 1-6s for continuous 256 levels color temperature adjustment.

For RGBW and RGB+W light type, short press to switch five levels white light brightness (10%, 25%, 50%, 75%, 100%);

long press 1-6s for continuous 256 levels white light adjustment, dimming range of 1-100%.

For RGCCT and RGB+CCT light type, short press to switch five levels color temperature (warm white - neutral white - cold white sequence);

long press 1-6s for continuous 256 levels color temperature adjustment.



: Short press get 24 kinds static RGB color;

long press 1-6s for continuous 256 levels saturation adjustment, namely change current static RGB color to mixed white slowly.



: Short press to change 10 dynamic mode; long press 2s run mode-cycle.



: For dynamic RGB mode, adjust speed, short press 5 levels, long press 2s get the default speed.

For static RGB color, adjust saturation, short press 5 levels, long press 2s to set minimum saturation (i.e. full 100% for RGB channels).



: Short press to switch five levels brightness (10%, 25%, 50%, 75%, 100%);

long press 1-6s for continuous 256 levels brightness adjustment.

Note:

- For RGBW light type: When the white light brightness is adjusted by button, the RGB channel auto-off.
- For RGB+W light type: When the white light brightness is adjusted by button, the RGB channel remains unchanged.
- For RGCCT light type: Short press button to switch to the color temperature state, RGB channel auto-off, then adjust the brightness of the current color temperature by button. Short press button to switch to the color light state, CCT channel auto-off, then adjust the brightness of the current color light by button.
- For RGB+CCT light type: Short press button to switch to the color temperature state, RGB channel remains unchanged, then adjust the brightness of the current color temperature by button. Short press button to switch to the color light state, CCT channel remains unchanged, then adjust the brightness of the current color light by button.
- Factory parameter setting: Long press the match/set key for 15s to restore the factory parameter setting, light type default is RGCCT.

Dynamic change mode list

For RGB/RGBW/RGB+W:

No.	Name	No.	Name
1	RGB jump	6	RGB fade in and out
2	RGB smooth	7	Red fade in and out
3	6 color jump	8	Green fade in and out
4	6 color smooth	9	Blue fade in and out
5	Yellow cyan purple smooth	10	White fade in and out

For RGCCT/RGB+CCT:

No.	Name	No.	Name
1	RGB jump	6	RGB fade in and out
2	RGB smooth	7	Red fade in and out
3	6 color jump	8	Green fade in and out
4	6 color smooth	9	Blue fade in and out
5	Color temperature smooth	10	White fade in and out

Match remote control (Optional)

End user can choose the suitable match/delete ways. Two options are offered for selection:

Use the Match/Set key

Match:

Short press match/set key, immediately press on/off key (single zone remote) or zone key (multiple zone remote) on the remote. The LED indicator fast flash a few times means match is successful.

Delete:

Press and hold match/set key for 10s, The LED indicator fast flash a few times means all matched remotes were deleted.

Use Power Restart

Match:

Switch off the power, then switch on power, repeat again. Immediately short press on/off key (single zone remote) or zone key (multiple zone remote) 3 times on the remote. The light blinks 3 times means match is successful.

Delete:

Switch off the power, then switch on power, repeat again. Immediately short press on/off key (single zone remote) or zone key (multiple zone remote) 5 times on the remote. The light blinks 5 times means all matched remotes were deleted.